

LEDS INDICATORS (TOP OF THE AMPLIFIER)









- BLUE LED (POWER) lights when the power is on.

- RED LED (PROT) illuminates only when there is a problem in the functioning of the device.

- RED LED (CLIP) flashes when the amplifier output begin to distort the sound.

SYSTEM TROUBLESHOOTING

If some problem occurs, the amplifier will shut down and the RED LED will flash alternately with the BLUE LED. As the problem occurred, the BLUE LED will blink a certain number of times. So we have a diagnosis according to the table below:

BLINKS	PROBLEM	SOLUTION
1 	 Short-circuit or overload in the output.	Verify if the speaker cables are properly isolated, observe the minimal impedance.
2 	 Excessive temperature.	Verify if the amplifier is in a vented spot.
3 	 Discharged battery.	Its normal the consumption of the battery for a long period, recharge your battery.
4 	 Battery tension alarm. Battery with tension over 16 Volts.	Find a specialized electrician to verify the system, alternator/battery.

Note: If only the RED LED blinks (BLUE LED OFF), turn on the device with the volume of CD/MP3-player down. If the problem persists, please contact us.

WHAT TO DO IN CASE OF PROBLEMS

NOT TURN ON:

- The cables are not properly connected (terminals +BATT, GND and REM). Make sure that all connections are mechanical and electrical contact.
- Fuses / breakers (external) are defective or burned. Pay attention to the correct value of the new fuse!

NO SOUND:

- The cables of the speakers or RCA plugs are not connected correctly.
- Check that the LEVEL control is not in the minimum.

NO SOUND/PROTECTION RED LED FLASHING:

- See diagnosis UP (SYSTEM TROUBLESHOOTING).
- The speakers or cables defectives thus check the speakers, cables and connections.

POOR SOUND QUALITY (DISTORTION):

- The speakers are overloaded, therefore decrease the level and redo the gain setting (See item 2 / OVERVIEW).

WEAK BASS:

- Cables speakers (+) and (-) are reversed, speaker out of phase (see Section 7 / overview).

MOTOR NOISE, HORN, SIGNAL LIGHT, ETC:

- Use suppressive cables in ignition candles.
- Use capacitors in the alternator, horn and ignition.
- Pass the RCA cable away from any other cable, because it is more sensitive to interference.
- Connect to power (+12 V) to separate the sound system. Use a fuse to 30 cm from the battery for protection.
- Make a good grounding of the amplifier. To do this removes the paint from the chassis of the vehicle at the desired point. Screw the cable using a ground terminal. To protect from oxidation, insulate with paint.
- Do not loop the ground wire. Avoid using several ground wires. Prefer a star connection, with all the ground wires aside from a single point.

www.stetsom.com.br - export@stetsom.com

STETSOM 
Unlimited Power

DIGITAL LINE

USER'S GUIDE

HALF BRIDGE

1K6 ES

SPECIFICATIONS

MODEL:	1K6 ES – 2 OHMS	1K6 ES – 1 OHM
Channels:	1	1
Power @ 13.8V Mono 1 Ohm:	-	1720 Watts RMS
Power @ 13.8V Mono 2 Ohms:	1780 Watts RMS	1035 Watts RMS
Power @ 13.8V Mono 4 Ohms:	1030 Watts RMS	-
Power @ 12.6V Mono 1 Ohm:	-	1600 Watts RMS
Power @ 12.6V Mono 2 Ohms:	1600 Watts RMS	820 Watts RMS
Power @ 12.6V Mono 4 Ohms:	830 Watts RMS	-
Minimum Work Impedance:	2 Ohms	1 Ohm
Minimum Input Sensitivity:	0,2V	0,2V
Total Harmonic Distortion:	< 0,9 % THD	< 0,9 % THD
Signal to Noise:	> 90 dB	> 90 dB
Freq. Response (-3dB) @ 8 Ohms:	10 Hz to 10 KHz	10 Hz to 10 KHz
Crossover LOW PASS:	50 Hz to 10 KHz	50 Hz to 10 KHz
Subsonic Filter:	10 Hz to 80 Hz	10 Hz to 80 Hz
Bass Boost:	0 to +12dB @ 45 Hz	0 to +12dB @ 45Hz
Work Voltage:	9,5 to 15 V	9,5 to 15 V
Consumption Music Signal (12,6 V):	1,7A to 77 A	1,7A to 77 A
Consumption BASS Signal (12,6 V):	1,7A to 155 A	1,7A to 154 A
Dimensions mm (A x L x C):	75 x 310 x 170	75 x 310 x 170
Weight:	2,2	2,2

OVERVIEW

AUDIO INPUT, CONTROLS AND OUTPUT AUDIO AMPLIFIED.

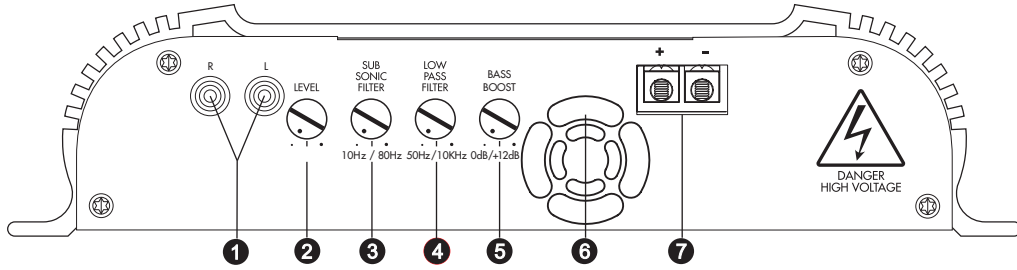

INPUT VENTILATION AND POWER.

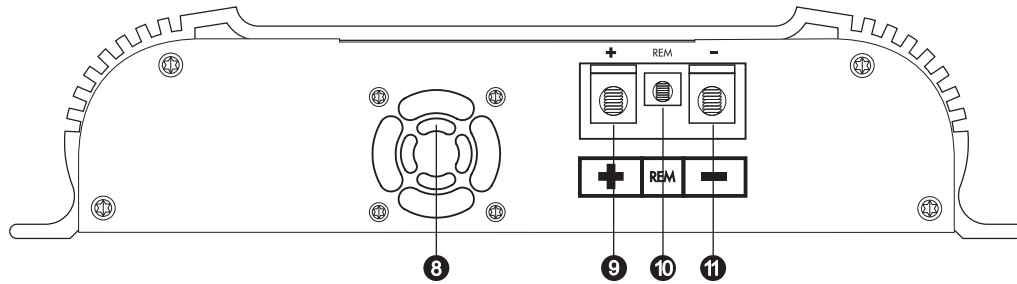

- 1) **INPUT - INPUT RCA L and R:** This entry should receive the signal by RCA cable that must be connected to the output RCA of CD/MP3-Player.
- 2) **LEVEL - GAIN CONTROL:** Controls the level of the input signal, allowing a proper adjustment to any CD/MP3-Player of the market. For practical purposes may be adjusted as follows:
 - a) CD/MP3-Player, put a musical signal and adjust the volume in 80% of maximum. For example, if the maximum volume of CD/MP3-player is 45 (100%), adjusting for 36 (80%).
 - b) In the amplifier, from the LEVEL at least, increase gradually until the clipping LED flashes.
 - c) Return the LEVEL slowly until the LED delete completely.
- 3) **SUB SONIC FILTER:** Provides a cut in the low frequency sound (subsonic). This filter is very useful when using speakers model woofers. In these cases, the woofers are not able to reproduce the subsonic and may even damage depending on the power and music used. Its adjustment varies from 10Hz to 80Hz.
- 4) **LOW PASS FILTER:** This control varies frequency cut filter 50 Hz to 10KHz. This filter allows passing only the sounds below the cut off frequency.
- 5) **BASS BOOST:** Reinforces the level of bass at low frequencies 25Hz to 110Hz. From 0 to +12 dB centered at 45Hz.
- 6) **VENTILATION OUTPUT:** allows the output of heated air from the amplifier.
- 7) **SPEAKERS OUTPUT:** This output is MONO. Beware of the polarity of the connections with the speakers and check the minimum impedance allowed in this output. Use cables of at least 8 mm².
- 8) **COOLER:** Cools the internal components of the amplifier. The air enter in the cooler and exits through the exhaust ventilation (item 6).
- 9) **+ BATT:** Connect the terminal (+ BATT) to the positive pole of the battery (+12 V) with a cable of at least 21.0 mm². It is extremely important that you use a fuse or circuit breaker to protect this cable to a maximum distance of 30 cm from the battery.
- 10) **REM - DRIVE REMOTE:** Connect the REM terminal to output for remote / antenna electric of CD/MP3-Player. So when you turn on your CD/MP3-Player, the amplifier automatically turns on. A cable of 0.5 mm² is sufficient.
- 11) **GND - GROUND CONNECTION:** Use cable with 21.0 mm². Plug the cable into the chassis of the vehicle.

NOTE: Always connect the cable GND (-) of CD-Player, or other devices at the same point.

INSTALLATION OF POWER (BATTERY)

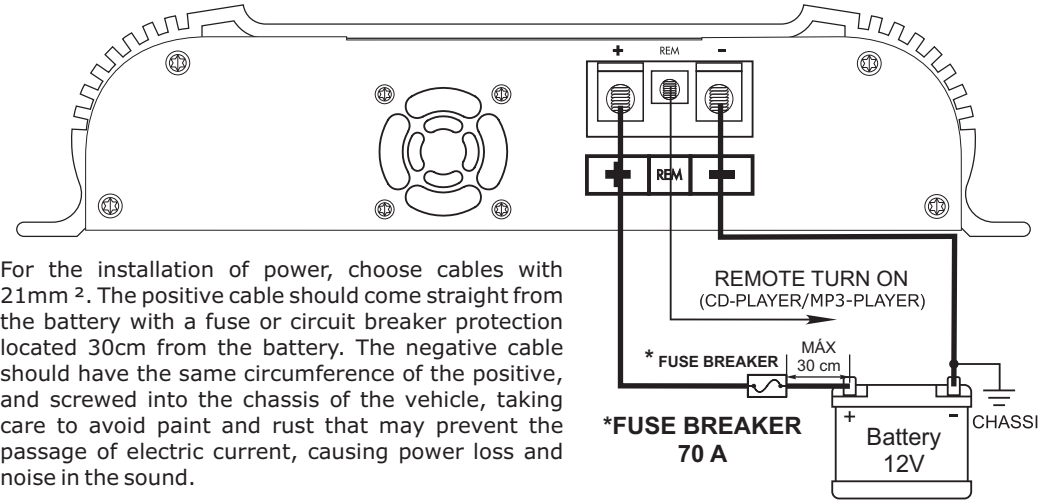

For the installation of power, choose cables with 21mm². The positive cable should come straight from the battery with a fuse or circuit breaker protection located 30cm from the battery. The negative cable should have the same circumference of the positive, and screwed into the chassis of the vehicle, taking care to avoid paint and rust that may prevent the passage of electric current, causing power loss and noise in the sound.

ATTENTION: USE OF EXTERNAL FUSE OR BREAKER BECAUSE THE AMPLIFIER HAS NO INTERNAL FUSE.

INSTALLATION OF OUTPUT SPEAKER

The cables of the speakers should be polarized (marked) to facilitate the identification of positive and negative. The circumference should be at least 8mm². Keep the cables from the speakers properly insulated. Beware of metal parts that can damage the insulation of cables.

INSTALLATION WITH 2 SPEAKERS

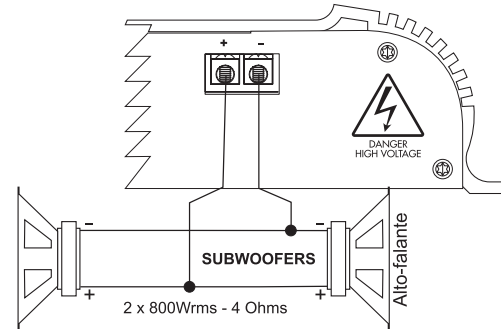

INSTALLATION WITH 1 SPEAKER DUAL COIL

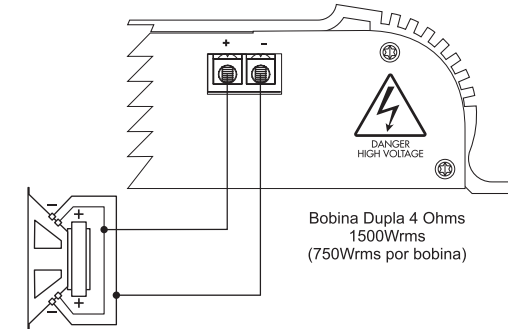

INSTALLATION WITH 2 WOOFERS AND 2 DRIVERS

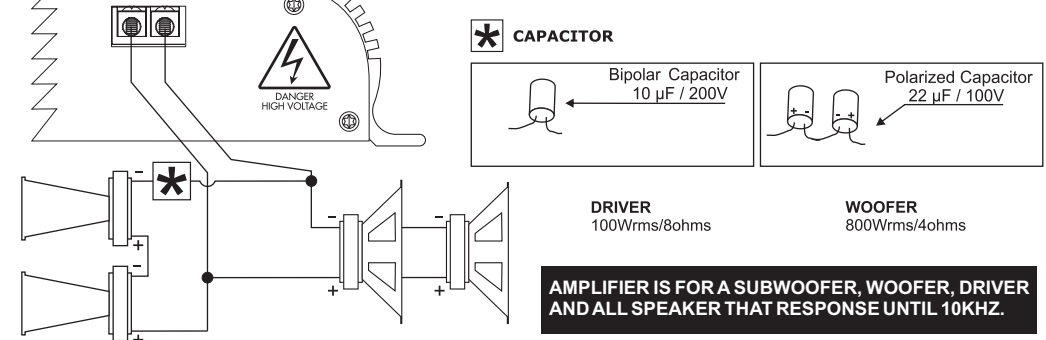

AMPLIFIER IS FOR A SUBWOOFER, WOOFER, DRIVER AND ALL SPEAKER THAT RESPONSE UNTIL 10KHZ.